

ROTAMAC

ROTAMAC MC, MCL

Metallic magnetic drive pumps according to ISO2858

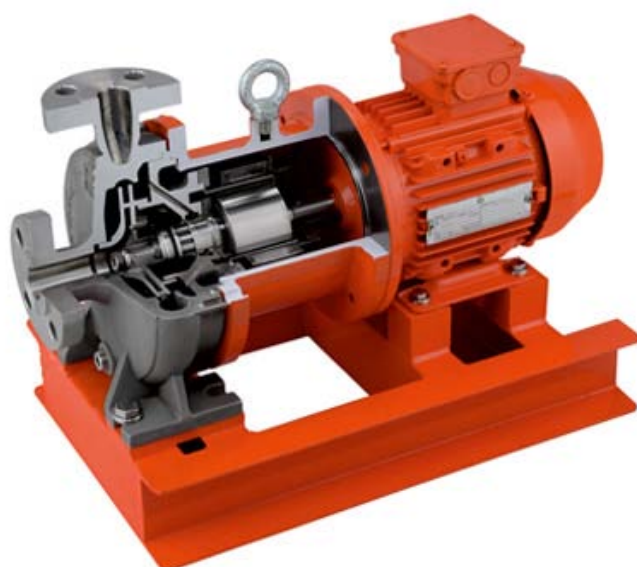

INTRODUCTION

This data booklet deals with MC, MCL series, horizontal end suction metallic magnetic drive centrifugal pumps for chemical process.

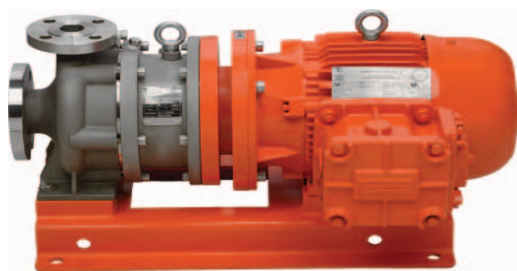

The MC/MCL is family of ISO pumps is designed in accordance with ISO 2858, making it ideal for worldwide industrial process application.

The MC is close coupled compact design with space saving and MCL long coupled with for life grease or oil lubrication.

Magnetic drive pumps are sealless pumps that use the technology of a drive magnet and inner magnet connected to an impeller to move fluid thru the pump. The drive magnet and inner magnet are separated by a rear casing, creating a seal-less containment. A magnetic drive pump will prevent the leakage of fluid and even more importantly save you from the loss of potentially dangerous and costly liquids.

With environmental concerns, seal-less pumps allow for zero fugitive emissions, allowing them to meet the necessary compliances.

Due to their simplicity, magnetic drive pumps save maintenance time replacing seals, dealing with hazardous leaks. With few moving parts, there is little chance for failure. Magnetic drive pumps are the answer for reliability and zero emissions.

These highly advanced and extremely energy efficient pumps are built to handle a huge variety of fluids reliably and absolutely safely.

APPLICATIONS

The MC, MCL series standardized pumps have been designed for several applications, such as chemical processing, speciality chemicals, biotechnology processing, chlor-alkali electrolysis, tank unloading, solvents, alkalis, toxic liquids, corrosive liquids, etc.

STANDARDISED

- Pump designed and manufactured in accordance with ISO 2858 / EN 22858
- Technical design based on DIN EN ISO 15783
- Balanced impeller according to ISO1940 grade G6.3, ensures smooth operation.
- Performance test of pumps based on ISO9906 and ANSI/HI14.6 grade 2B

ADVANTAGES

- Zero leakage to the atmosphere. Magnetic drive pumps will prevent the leakage of any fluid, saving you from the loss of potentially toxic, explosive, corrosive or costly liquids.
- Hydraulically balanced impeller for minimum bearing loads, low vibration levels and excellent smooth running characteristics.
- Back pull out design facilitates fast and easy to assembly and disassembly without any special tool.
- Dimension conform to DIN EN ISO 2858, making the MC/MCL easy to retrofit into any installation to replace old pumps.
- High reliability, safe, trouble-free operation, less failure and reduce life cycle cost.

WORKING CONDITION

- Liquid pumping temperature up to +180 °C, up to 250 °C as option
- Maximum permissible pressure: PN16
- Flow rate: up to 150 m³/h
- TDH: up to 95 m
- Kinematic viscosities: up to 350 mm²/s
- Speed: 1450 / 2900 rpm for frequency 50 Hz, 1750 / 3500 rpm for frequency 60 Hz

MATERIAL AND CONSTRUCTION

- Metallic parts: 304 / 304L / 316 / 316L / duplex stainless steel, nickel base alloys (e.g. hastelloy)
- Bearing: sintered silicon carbide (SSiC) or customized materials
- Shaft seal: sealless (magnetic coupling)
- Lubrication: oil / grease (for MCL series)

The pump is driven by a standard IEC foot mount motor or diesel engine. The power is transmitted through a direct, non-spacer or spacer coupling.

The baseplate is fabricated from steel, drill and tap bases, secure pump and motor to base, made more rigid and pre-alignment before delivery for MCL series.

MC / MCL Series, Metallic Magnetic Drive Pumps

Selection Charts

n = 2900 rpm

Curves on this page are for guidance only. Refer to the performance curves on each model.

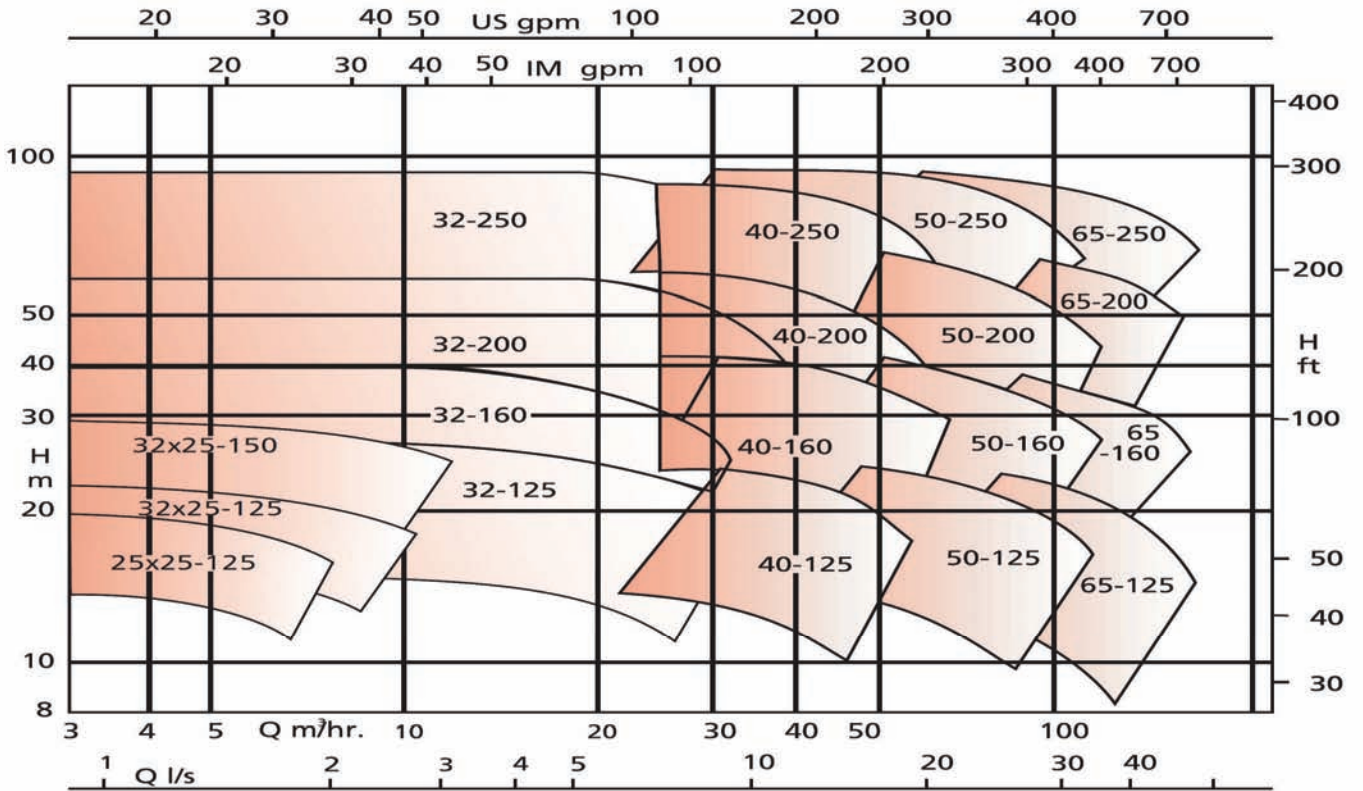

n = 1450 rpm

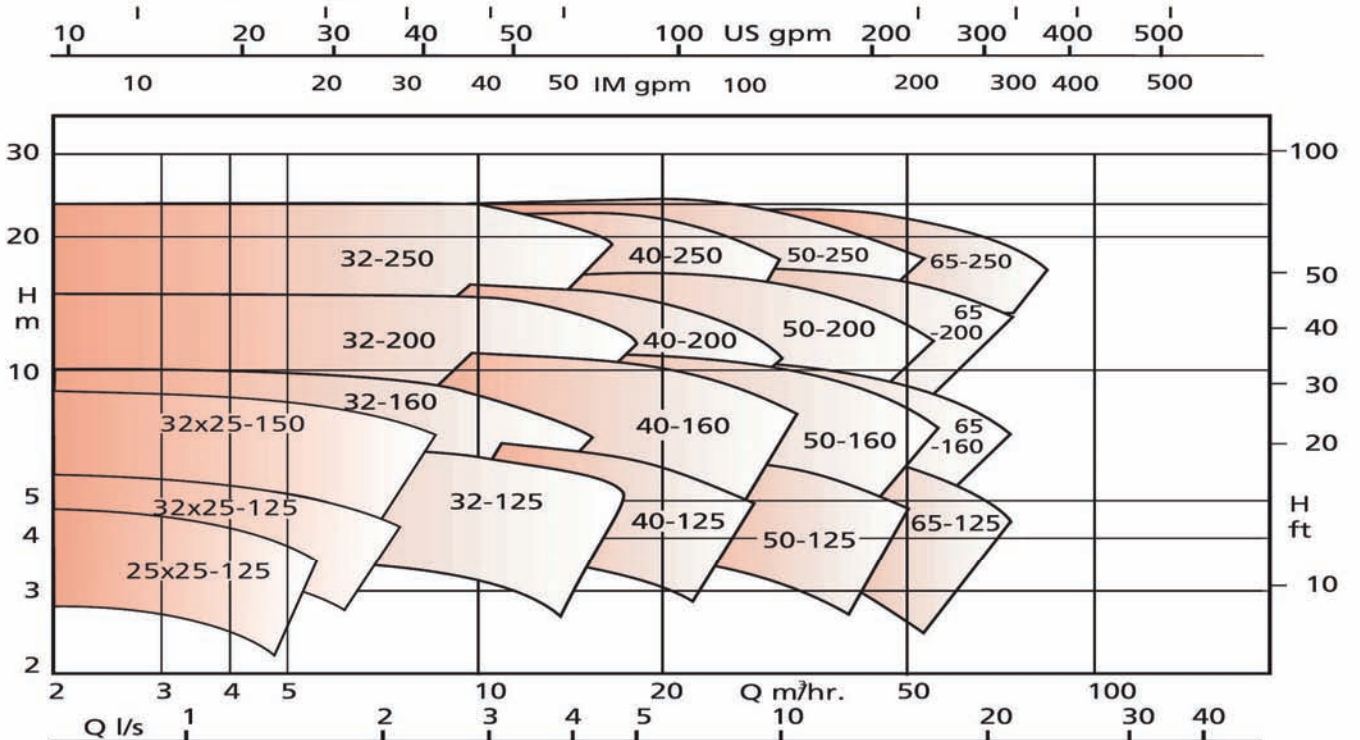

PUMP SECTIONAL DRAWING AND PARTS LIST

Pump construction is a little different depending on size

MC SERIES (CLOSE COUPLED)

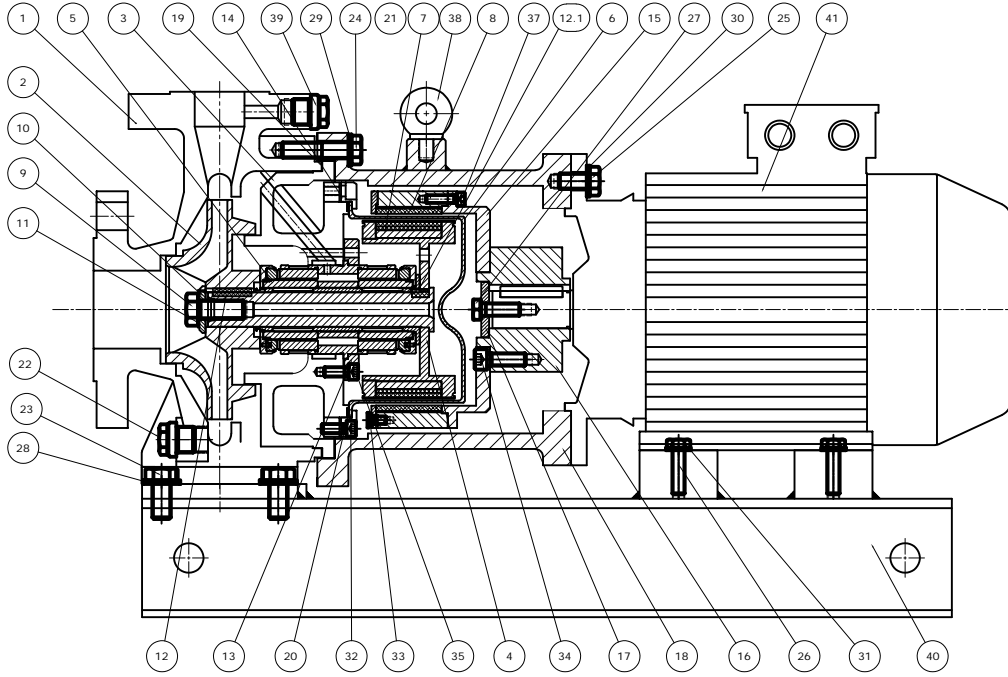

item	description
1	casing
2	impeller
3	casing cover
4	shaft
5	cartridge bearing
6	shell
7	inner magnet
8	outer magnet
9	impeller bolt
10	impeller washer
11	lock washer
12-12.1	shaft key
13	bearing lock plate
14	shell lock plate
15	magnet carrier
16	drum
17	drum lock washer
18	adapter
19	casing gasket
20	shell gasket
21	magnet protection ring
22	casing plug
23-26	hex nut
27	hex screw
28-31	washer
32-37	allen cap screw
38	eye bolt
39	plug
40	base frame
41	motor

MCL SERIES (LONG COUPLED)

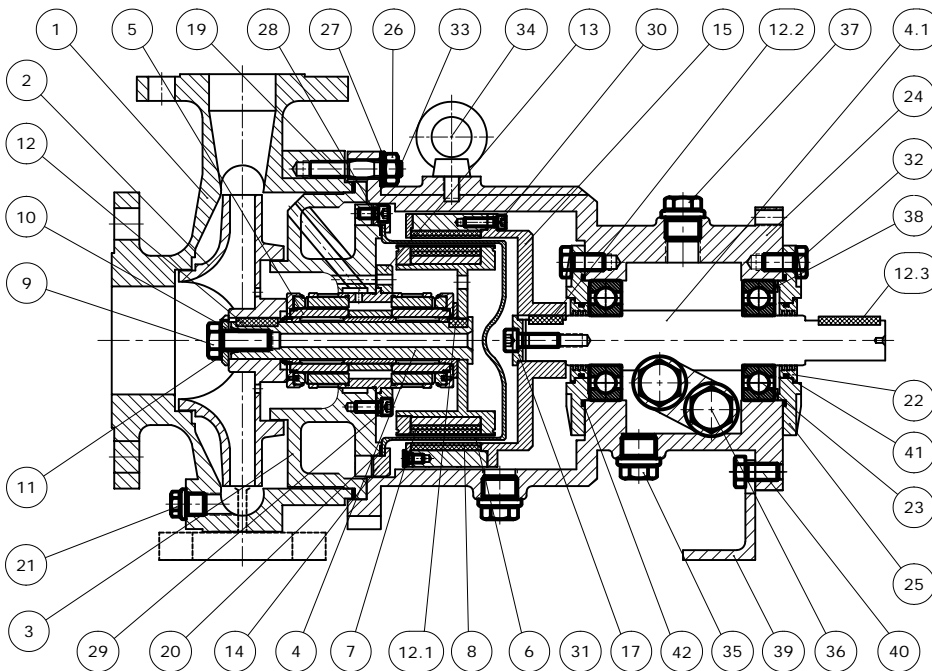

1	casing
2	impeller
3	casing cover
4-4.1	shaft
5	cartridge bearing
6	shell
7	inner magnet
8	outer magnet
9	impeller bolt
10	impeller washer
11	lock washer
12-12.3	shaft key
13	bearing lock plate
14	shell lock plate
15	magnet carrier
17	lock washer
19	casing gasket
20	shell gasket
21	casing plug
22	labyrinth seal
23	bearing
24	bearing housing
25	bearing cover
26	hex nut
27	washer
28-31	allen cap screw
32	hex cap screw
33	studs
34	eye bolt
35	plug
36	oil level indicator
37	oil plug
39	support bracket
40	hex cap screw
41-42	o-ring

MC / MCL Series, Metallic Magnetic Drive Pumps

Economical Operation, Standardized,
Reliable, Simple and Easy To Maintain



MCL MAGNETIC DRIVE PUMPS

The MCL series of pump is the long coupled version, constructed with metallic parts. The units are designed in accordance with the chemical process pump specification and dimensions according to ISO 2858 / EN 22858, which allow design pressures of 16 bar.

Stainless steel or nickel base alloys magnetic drive pumps feature a zero-vapour loss and corrosion resistant design for heavy duty chemical and pharmaceutical applications. Suitable for both high temperature and low temperature executions from -35° up to $+180^{\circ}\text{C}$ as standard and $+250^{\circ}\text{C}$ as option, for handling aggressive, toxic and hazardous liquids in the chemical, petrochemical and pharmaceutical industries.

The pumps are manufactured on a bare shaft execution, are equipped with a reliable oil or grease lubricated bearing bracket which has been developed to suit the most arduous of duties.

SPARE PARTS AND MAINTENANCE

The use of genuine MC/MCL parts will provide the safest and most reliable operation of your pump.

MC/MCL pumps quality control procedures ensure the parts are manufactured to the highest quality and safety levels.



SERVICE FRIENDLY WITH BACK-PULL-OUT

Maintenance is simple in all the MC/MCL models thanks to the use of standard components and the Back-Pull-Out principle.

The process design permits dismantling of the complete bearing unit towards the drive end, without the pump casing having to be disconnected from the piping. If a spacer coupling is used it is also unnecessary to disconnect the motor.

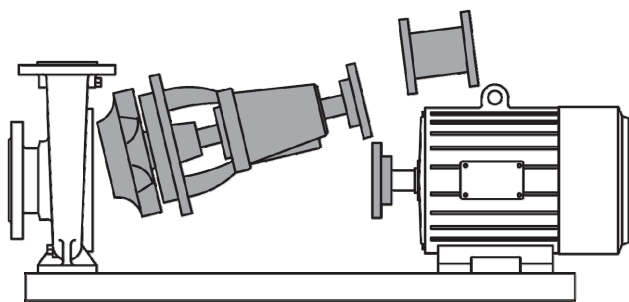

ROTAMAC

- Standardized End Suction Pumps
EN733/DIN24255, ISO2858/ISO5199
ASME B73.1, API610
- Split Casing Double Suction Pumps
- Solid Handling Pumps
Slurry/Vortex/Semi-open/Open/Non clog
- High Pressure Multi-Stage Pumps
- Self-Priming Pumps
- Submersible Pumps
- Close Coupled Pumps
- Vertical Multi-Stage / Immersible Pumps
- Vertical Sump Pumps
- Vertical Turbine Pumps
- Mixed / Axial Flow Pumps
- Liquid Ring Vacuum Pumps
- Chemical Process Plastic Pumps
- Fire Fighting Pump Packages (NFPA20)
- Booster Pump Packages
- Trailer Mounted Pumps

436 Soi On-Nuch 39, Sukhumvit Rd.,
Suanluang, Bangkok 10250 - Thailand

T : +66 2721 3860

F : +66 2721 3869

E : sales@energytechnology.co.th

www.energytechnology.co.th

ROTAMAC can help relieve the stresses and reduce the life cycle costs associated with the most important aspects of plant operation.

Dedicated to delivering the highest quality support, ROTAMAC services and solutions integrates hydraulic, mechanical and materials engineering knowledge with creative solutions to improve equipment reliability and system performance, reduce energy consumption and improve the safety and environmental impact of operations.

Pump Services and Repair



Capabilities Overview

Design

- Equipment Selection and Optimization
- Material Selection
- System Design
- System Optimization

Start-up

- Equipment Installation
- Laser Alignment
- Commissioning and Running test
- Operator Training
- On-site Project Supervision
- On-site Troubleshooting

Operation and Maintenance

- Equipment Inspection
- Repair & Overhaul
- Advanced Diagnostics
- Service Maintenance Contracts